

A & A PRODUCT. Price List' 2012

ACCESSORREIS

ACCESSORIES

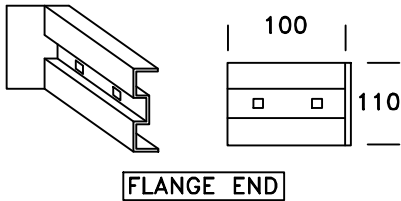

FLANGE END

Description	Type	T (mm.)	Unit Price (Bath)
Splice Plate	ASP	1.6	130
Vertical Adjustable	AVA	1.6	250
Horizontal Adjustable	AHA	1.6	600
Hold Down Clamp	HDC	1.6	88
J-Lock	JL	8.0	76
U-Channel(For J-Lock)	U	2.0	300.-/M
Flange End	FE	2.0	200

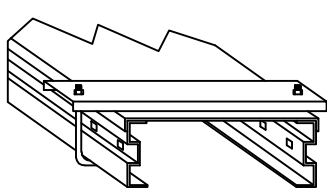

J-LOCK

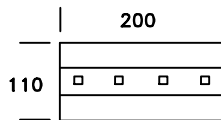
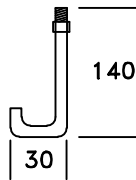

SPLICE PLATE

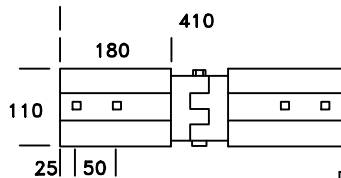
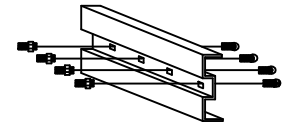

HORIZONTAL ADJUSTABLE

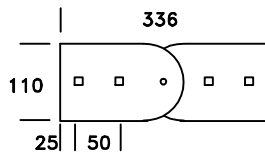
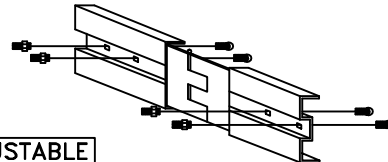

VERTICAL ADJUSTTABLE

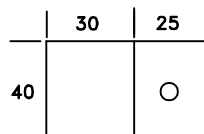
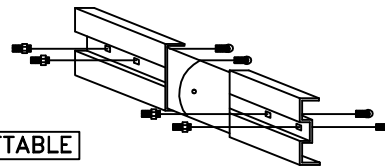

HOLD DOWN CLAMP

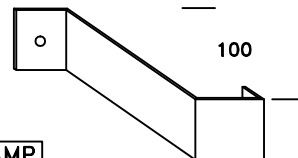

U-CHANNEL (FOR J-LOCK)

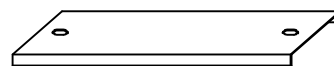

ACCESSORIES PRODUCT. Price List' 2012

BRACKET SUPPORT

Epoxy Powder Painted

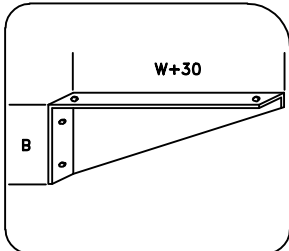
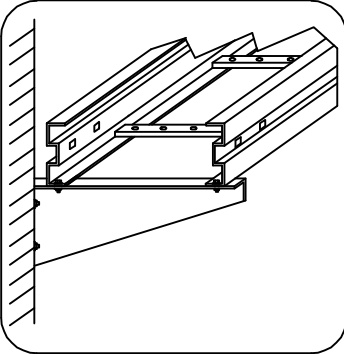

ABS	TYPE	B (mm.)	Thickness (mm.)	Unit Price (Bath)
	(W),mm.			
ABS200	200	100	2.0	260
ABS300	300	150	2.0	360
ABS400	400	180	2.0	440
ABS500	500	200	2.0	500
ABS600	600	250	2.0	580
ABS700	700	350	2.0	700
ABS800	800	350	2.0	700
ABS900	900	350	2.0	760
ABS1000	1000	400	2.0	800

HANGING SUPPORT

Epoxy Powder Painted

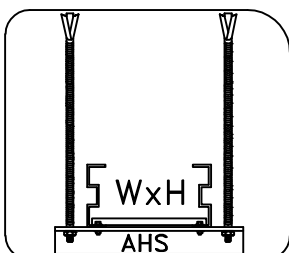
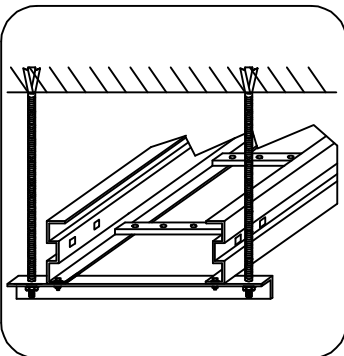

AHS	TYPE	Length (mm.)	Thickness (mm.)	Unit Price (Bath)
	(WxH),mm.			
AHS200	200x100	280	2.0	148
AHS300	300x100	380	2.0	168
AHS400	400x100	480	2.0	188
AHS500	500x100	600	2.0	210
AHS600	600x100	700	2.0	240
AHS700	700x100	800	2.0	280
AHS800	800x100	920	2.0	316
AHS900	900x100	1,040	2.0	340
AHS1000	1000x100	1,160	2.0	380